

SAFEGUARD TOTALGUARD™



ENGLISH
USER'S GUIDE

Introduction**Safety warnings****BASIC OPTIONS**

1.	Your Marmitek surveillance system	5
1.1	Important properties	6
1.2	Signal range	7
2.	The security console	7
2.1	Installing the console	8
2.1.1	Connecting the telephone wire	8
2.1.2	Connecting the AC adapter	8
2.1.3	Installing the emergency batteries	8
2.2	Mounting the security console	9
2.3	The menus	9
2.3.1	Choosing your language	10
2.3.2	The menu in English	11
3.	Installing remote controls	12
3.1	Key Chain Remote Control KR21	12
3.1.1	Using the Key Chain Remote Control	12
3.1.2	Registering the Key Chain Remote Control	12
3.2	Comfort Remote Control SH624 (standard with TotalGuard, optional with SafeGuard)	13
3.2.1	Using the Comfort Remote Control	13
3.2.2	Registering the Comfort Remote Control	13
4.	Installing the sensors	14
4.1	Door/Window Sensor DS90	14
4.1.1	Mounting the Door/Window Sensor DS90	14
4.1.2	Using the Door/Window Sensor	14
4.1.3	Registering a Door/Window Sensor	15
4.2	Motion Detector MS90	15
4.2.1	Mounting the Motion Detector MS90	15
4.2.2	Using the Motion Detector	16
4.2.3	Registering a Motion Detector	16
4.3	Smoke Detector SD10 /SD90	17
5.	Setting up the security console (SC9000)	17
5.1	Setting the clock	17
5.2	Storing phone numbers	18
5.3	Recording your own message	18
6.	Using the security system	19
6.1	Setting the alarm	19
6.2	Panic alarm	20
6.3	What happens when the alarm goes off?	21
6.4	Disarming the system	21
6.5	Error messages	21

7. Prevention and comfort - 'Home Automation'	22
7.1 Introduction	22
7.2 Addressing your modules	23
7.3 Installing the LM12 Lamp/Dimmer Module	23
7.4 Alarm functions of the Lamp/Dimmer Modules	23
7.5 Comfort functions of the KR21 Key Chain Remote Control	23
7.6 Comfort functions of the SH624 Comfort Remote Control	24
7.7 Comfort functions of the security console	24
7.8 Setting the timer	24
7.9 Clearing the timer settings	25
EXTRA OPTIONS	
8. Advanced system functions	26
8.1 Setting the delays	26
8.2 Clearing the memory of your security system	26
8.3 Changing the access code (PIN)	27
9. Advanced security functions	27
9.1 Disarming the siren for silent alarm	27
9.2 Arming the chime	27
9.3 Using wired inputs	28
9.4 Adding a wired sensor to the Door/Window Sensor DS90	28
9.5 Emergency sensors	29
9.6 Sensor 27-32 Marmitek X-10 ON/OFF trigger function	29
9.6.1 Apply/Cancel a sensor	29
9.6.2 Using the Marmitek X-10 ON/OFF trigger function	30
9.7 Deregistering a Door/Window Sensor	30
9.8 Deregistering a Motion Detector	30
10. Advanced Home Automation functions	31
10.1 Checking the status of the security system	31
10.2 Installing an extra siren (Marmitek PH7208)	31
10.3 Using an external universal siren	31
10.4 Transceiver function	31
10.5 All Home Automation functions at a glance	32
10.6 Basic address for Home Automations functions	32
11. Telephone functions	34
11.1 Calling the security system	34
11.2 Activating the call-in function	34
11.3 Operating the alarm functions via an outside phone	34
11.4 Operate lights and equipment via an outside phone	35
12. Changing the batteries	35
13. Frequently asked questions	36
Labels	38
Technical data	39

INTRODUCTION

Introduction

Thank you for purchasing this Marmitek security product. Marmitek security systems are made with care and are of the highest quality. Please read this user manual carefully and follow up all the instructions.

In this user manual you will find texts marked with a ☺ sign. These texts contain extra information about the functions and can be skipped.

Safety warnings

- To prevent short circuits, this product should only be used inside and only in dry spaces. Do not expose the components of your security system to rain or humidity. Do not use the product close to a bath, swimming pool etc.
- Only connect the adapters to the mains after you have checked whether the mains voltage corresponds with the value on the type tags. Never connect an adapter or cable when it is damaged. In that case, contact your supplier.
- Batteries: keep batteries out of the reach of children. Dispose of batteries as chemical waste. Never use old and new batteries or different types of batteries together. Remove the batteries when you are not using the system for a longer period of time. Check the polarity (+/-) of the batteries when inserting them in the product. Wrong positioning can cause an explosion.
- Do not expose the components of your systems to extremely high temperatures or direct sunlight.
- Do not open the product: The device contains live components. The product should only be repaired or serviced by a qualified repairman.
- In case of improper usage or if you have opened, altered and repaired the product yourself, all guarantees expire. Marmitek does not accept responsibility in the case of improper usage of the product or when the product is used for purposes other than specified. Marmitek does not accept responsibility for additional damage other than covered by the legal product responsibility.
- This product is not a toy. Keep out of reach of children.

1. Your Marmitek surveillance system

The contents of your set:

The Marmitek SafeGuard system is an effective security system for your home. In this kit you will find the following components:

1. Security console SC9000
2. Motion Detector MS90
3. Door/Window Sensor DS90
4. Key Chain Remote Control KR21
5. AC adapter
6. Accessories: batteries, telephone wire, telephone plug



Marmitek SafeGuard-system

BASIC OPTIONS



Marmitek TotalGuard-system

The Marmitek TotalGuard system is identical to the SafeGuard system, but also contains components for prevention and comfort. The TotalGuard system also contains the following components:

1. Lamp/Dimmer Module LM12
2. Comfort Remote Control SH624
3. One extra DS90 Door/Window Sensor

© All components of the TotalGuard system are available separately and are compatible with the SafeGuard system.

1.1 Important properties

- Receive a telephone message in case of an emergency, wherever you are. The built-in telephone dialler can dial six different telephone numbers.
- The person called receives a spoken message indicating a burglary or fire alarm is in progress.
- Intelligent sensor control: the console checks functions and battery status.
- Menu control in your own language makes installation and configuration easy.
- Use the phone to listen to what is causing the alarm in your home.
- You can register up to 30 wireless sensors with the console.

- You can use up to 16 wireless remote controls.
- 2 inputs for wired sensors.
- Silent alarm possible (no siren).
- By calling the system, you can control the system remotely and check the status. The TotalGuard also lets you switch on the lights.
- Prevention: Your lights are switched on and off in such a way that it appears as if you are home.

1.2 Signal range

The sensors have an open field range of 100 m. Walls, ceilings and other large object will influence the range. The range depends on your personal living conditions, but is usually between 15 and 30 m.

One other factor that can decrease the range is the presence of other distorting high-frequency signals on the same frequency (433MHz). RF wireless headphones and wireless speakers can influence the range. They cannot cause a false alarm. Wireless phones or networks do not influence the system.

2. The security console

- (1) Display.
- (2) ARM HOME button
Alarm function for when you are at home. All Door/Window Sensors are activated, but the Motion Detectors remain unarmed.
- (3) ARM AWAY button
Full alarm. All sensors are activated.
- (4) ARMED Indicator
Lights up when the alarm is switched on.
- (5) BATTERY Indicator
Lights up when the back-up batteries are empty or not installed.
- (6) Telephone connection.
- (7) AC adapter connection.
- (8) Wired inputs.
- (9) Tamper contact.
- (10) Emergency battery compartment.
- (11) Console buttons.
- (12) Menu Start \uparrow - Call up the menu or step up in the menu.
- (13) Menu Start \downarrow - Call up the menu or step down in the menu.
- (14) ON - Switch on a Marmitek X-10 Module (see 7.7).
- (15) OFF - Switch off a Marmitek X-10 Module (see 7.7).
- (16) OK - Confirm setting.
- (17) Clear/bypass - Clear the setting, go up one level in the menu, Bypass function for switching of a sensor.
- (18) Built-in microphone.

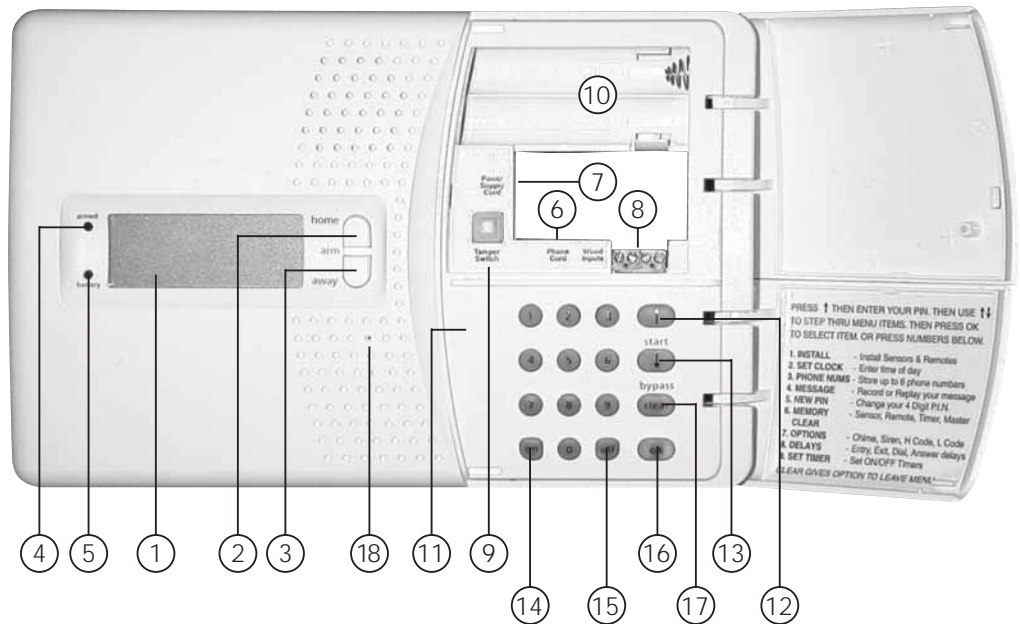

BASIC OPTIONS

Display:

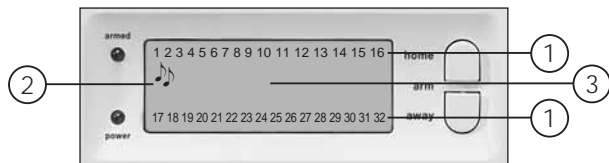

1. Zone numbers

Every sensor represents a so-called zone in the system. There are 30 zones for wireless sensors (numbers 1-30 on the display) and 2 zones for wired sensors (numbers 31 and 32 on the display).

Zone numbers on: Door or window is open.

Zone number flashing slowly: There is a problem with the sensor (6.5).

Zone number flashing quickly: The sensor has been switched off with the Bypass function (6.5).

2. Chime

Chime is switched on when the system is switched off. When this function is activated, you hear a pleasant ding-dong when someone enters the house (9.2).

3. Space for menu texts and clock

2.1 Installing the console

2.1.1 Connecting the telephone wire

Open the top compartment on your console. Connect the telephone wire to the corresponding connection (6). You can fixate the wire by looping it behind the hooks on the back of the console.

In case of an analogue phone connection

Insert the other end of the telephone wire into the telephone plug included and connect this to your telephone socket.

☺ In case of an ISDN connection

The console cannot be connected directly to an ISDN connection! If you are using ISDN, you need to connect the alarm system to an analogue connection of your ISDN console. The telephone wire included, without the plug, fits directly into the analogue input of your ISDN console. If there are no analogue inputs, please use a converter (check with your telecom supplier). You will most likely have to dial a 0 on the console to get an outside line. This 0 needs to be programmed in with the telephone numbers to be able to dial out (see 5.2). You also need to keep in mind that with ISDN in the case of a power failure your alarm system can no longer dial out. The connection can only be guaranteed with an analogue line.

2.1.2 Connecting the AC adapter

Connect the AC adapter to the corresponding connection (7). Plug the adapter into a 230V wall socket. You can fixate the wire by looping it behind the hooks on the back of the console. When connecting the adapter and opening the top compartment of your console, you will see the word 'TAMPER' on the display. After closing the compartment, enter your PIN code (factory settings 0000, see 8.3) to remove the word 'TAMPER'. The display will now read 'DISARMED' and you will hear a double tone to confirm.

☺ Please use the AC adapter included in the set

2.1.3 Installing the emergency batteries

Insert 4 AA batteries in the battery compartment (10). Do not forget to check the polarity (+/-).

Preferably use alkaline batteries (not rechargeable batteries). After inserting the batteries and closing the compartment, enter your PIN code (factory settings 0000, see 8.3) to remove the word 'TAMPER'. The display will now read 'DISARMED' and you will hear a double tone to conf

2.2 Mounting the security console

Choose a good space for the console and make sure you have a wall socket (230V) and a telephone connection close by. For optimal range it is best to mount the console central to the objects you wish to secure. This ensures that the distance between the console and the sensors is as short as possible and the range will be sufficient.

Please also ensure that:

1. the console is not placed close to large metal object (radiators, oven, etc.);
2. you have easy access to the console;
3. the console is not too close to other electronic equipment, such as your telephone system, computer or TV.

You can place the console on any flat surface (table, etc.) or mount it onto the wall.

Mounting the console onto the wall

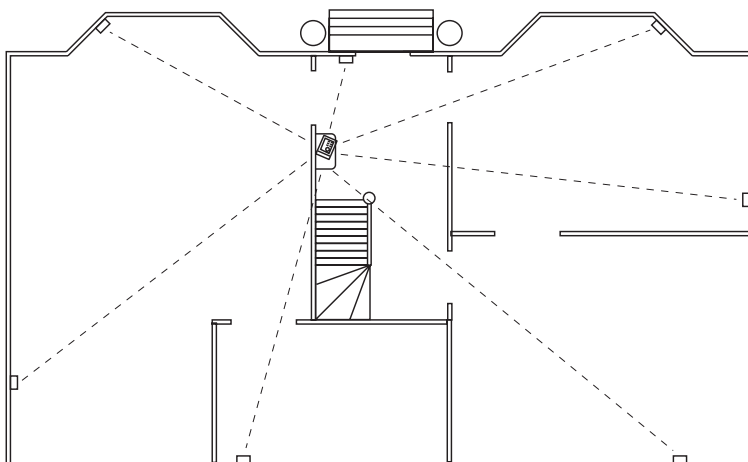

The console can be mounted onto the wall using two screws. On the back of the console you will find two slot holes (heart to heart distance 96mm). Fitting screws are included in the set.

Setting the console on a flat surface

The rubber caps make sure the console will not move around when using the console.

2.3 The menus

After connecting the console, the display will read 'HOME CONTROL'. The time will be displayed on the bottom line (for setting the time, see 5.1).

☺ *If you do not see the words HOME CONTROL but TAMPER, you need to close the top compartment on the console. After closing the compartment, enter your PIN code (factory settings 0000, see 8.3) to remove the word 'TAMPER'. The display will now read 'DISARMED' and you will hear a double tone to confirm. Then the text HOME CONTROL will be shown.*

BASIC OPTIONS

2.3.1 Choosing your language

All menu items are displayed in English. You can choose any of the other available languages. You can do this as follows: To access the menu, press the menu **↑** or menu **↓** button. The display will now read 'ENTER PIN'.



Enter the 4-digit PIN code (factory setting 0000. See 8.3 for changing the PIN code). For every digit entered, a * will appear on the display. When the PIN code has been entered correctly, the first menu item will show up on the display.



Use the menu buttons **↑/↓** to go to menu item 7. Options. Press OK to select this menu item. You can also go to this menu item directly by pressing a 7 on the number pad.



Use the menu buttons **↑/↓** to go to menu item Languages. Press OK to select this submenu item.



Use the menu buttons **↑/↓** to select your language. Press OK to confirm.

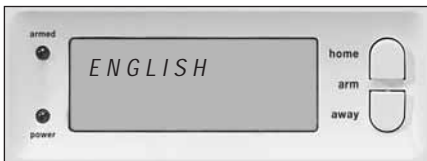

Press Clear and then 1 (=Yes) to quit the menu.



☺ *Attention: This English language user manual will only use the English menu items.*

2.3.2 The menu in English

The menu items in the English language menu are:

- | | |
|---------------|---|
| 1. INSTALL | Registering and deregistering sensors and remote controls. |
| 2. SET CLOCK | Setting the clock (5.1). |
| 3. PHONE NUMS | Setting the phone numbers (5.2). |
| | Submenu: |
| | PHONE 1 |
| | PHONE 2 |
| | PHONE 3 |
| | PHONE 4 |
| | PHONE 5 |
| | PHONE 6 |
| 4. MESSAGE | Recording and checking your own spoken message (5.3). |
| Submenu: | 1. RECORD Record your own spoken message |
| | 2. REPLAY Listen to your own spoken message |
| | 5. NEW PIN Change your PIN code (8.3). |
| | 6. MEMORY CLEAR Clear all sensors, remote controls, timers or settings (8.2). |
| | Submenu: |
| | CLEAR ALL SENSORS Remove a registered sensor. |
| | CLEAR ALL REMOTES Remove a registered remote control. |
| | CLEAR ALL TIMERS Remove all timer settings at once. |
| | MASTER RESET Clear the memory. |
| 7. OPTIES | |
| Submenu: | Submenu: |
| | CHIME - CHIME ON/CHIME OFF Chime on/off when system off (9.2). When the chime is switched on, the display will show a ↓ symbol. |
| | SIREN - SIREN ON/SIREN OFF Switch off siren for silent alarm (9.1). |
| | HOUSECODE Change the HouseCode for Home Automation functions (10.6). |
| | UNITCODE Change the UnitCode for Home Automation functions (10.6). |
| | ANSWER TYPE ANSWER ON/ANSWER OFF/VOICE MAIL (11.2). |
| | SENSOR MODE Use sensors as emergency sensor. See (9.5). |
| | LANGUAGE ENGLISH/FRANÇAIS/DEUTSCH/NEDERLANDS/ITALIANO/ESPANOL/PORTUGUES/SVENSKA/ROMANA/TÜRKÇE. |
| 8. DELAYS | |
| Submenu: | |
| | ENTRY DELAY The time you get to switch off the system after entering your house (8.1). |
| | EXIT DELAY The time you get before the system is switched on when you leave your house (8.1). |
| | DIAL DELAY Delay before the system calls out in case of an alarm (8.1). |
| | ANSWER DELAY Delay before the system picks up the phone when dialling in (8.1). |
| 9. SET TIMER | |
| Submenu: | NEW TIMER Setting a new timer (7.8). |

3. Installing remote controls

3.1 Key Chain Remote Control KR21

1. CONTROLE INDICATOR
Lights up when the remote control transmits radio signals when pressing the buttons. If the indicator light is not very bright, the batteries should be replaced.
2. ARM
Switches on the alarm in Arm Away mode (all sensors activated).
3. DISARM
Switches off the security system.
4. LIGHTS ON
Switches on your light modules (7.5).
5. LIGHTS OFF
Switches off your light modules (7.5).
- 7+8. PANIC
If the (red) buttons 7 and 8 are pressed together, the panic alarm is activated (6.2).
9. BATTERY COMPARTMENT
The battery compartment can be found in the remote control.

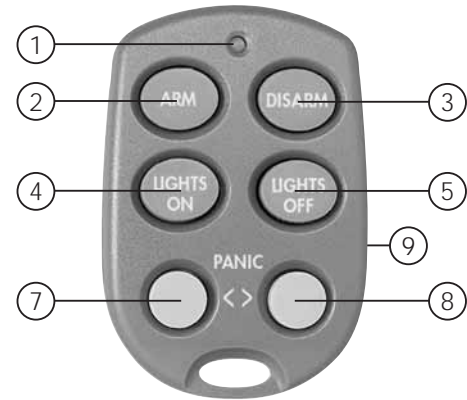

3.1.1 Using the Key Chain Remote Control

1. BATTERIES
A new KR21 contains fully charged batteries.
 2. ACTIVATING THE KR21.
Keep the ARM button on your remote control pressed for 4 seconds. Release the button. The remote control has now chosen a unique code, which can be registered with your console.
- ☺ *When pressing the ARM button the LED should flash quickly a few times. When the LED lights up and stays lit, you need to reactivate the KR21*

3.1.2 Registering the Key Chain Remote Control

1. To access the menu, press the menu **↑** or menu **↓** button. The display will now read 'ENTER PIN'.
 2. Enter your 4-digit PIN code (factory setting 0000. See 8.3 for changing the PIN code). For every digit entered, a * will appear on the display.
 3. When the PIN code has been entered correctly, the word 'INSTALL' will show up on the display.
 4. Press OK. The display now reads 'INSTALL ZONE'.
 5. Press the ARM button on your key chain remote control. The console will beep to confirm. The display will read 'RMOT 1 SET'.
- ☺ *If you have more than 1 remote control installed, it will read e.g. RMOT 2 SET, RMOT 3 SET, ... RMOT 16 SET. You can register up to 16 remote controls.*
6. Repeat step 5 for every remote control you wish to register.
 7. Press CLEAR to go back to the main menu. Press CLEAR again to quit the menu. To confirm your choice, press 1 for Yes or 2 for No. If you choose Yes, you will quit the menu. If you choose No, you go back to the main menu.

☺ *You can also remove remote controls from the menu, e.g. when you have lost a remote control. This method is described in 8.2.*

☺ *Read chapter 12 for information on replacing the batteries..*

3.2 Comfort Remote Control SH624 (standard with TotalGuard, optional with SafeGuard, art. no. 09170)

1. PANIC
With this red button the panic alarm can be activated immediately.
2. CONTROL INDICATOR
Lights up when the remote control transmits radio signals when pressing the buttons.
If the indicator light is not very bright, the batteries should be replaced.
3. CONTROL BUTTONS
For operating the security system and for the comfort functions (see 7.6).
4. DIMMER BUTTON (see 7.6)
5. MODUS SWITCH
Switch to the SEC setting to use the security functions. For settings 1 and 2, see 7.6.
SWITCH IN SEC SETTING:
 - ARM HOME: The security system is partly armed. All door/widow sensors are activated, while the motion detectors are switched off.
 - ARM AWAY: The security system is fully armed. All sensors are activated.
 - DISARM: Switches off the security system.
6. HOUSECODE SWITCH
Leave the switch set to A for now (see 10.6 for more information).

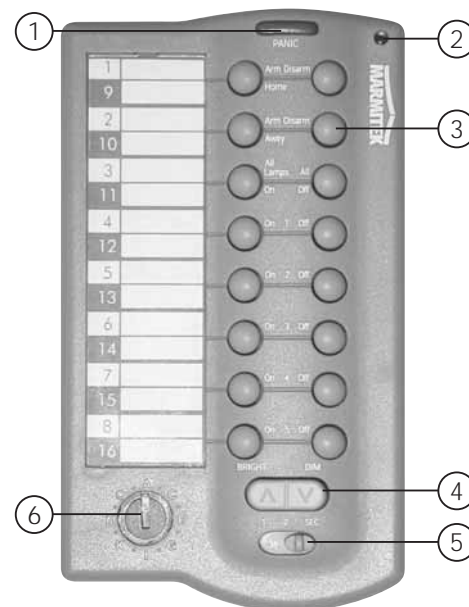

3.2.1 Using the Comfort Remote Control

1. INSERTING THE BATTERIES
IMPORTANT: When inserting the batteries, the switch should not be in setting 2!
Open the battery compartment on the back of the remote control and insert the batteries (4x AAA, alkaline). Do not forget to check the polarity (+/-). Close the compartment.
2. ACTIVATING THE SH624
Press the 'PANIC' button.

3.2.2 Registering the Comfort Remote Control

1. To access the menu, press the menu or menu button. The display will now read 'ENTER PIN'.
2. Enter your 4-digit PIN code (factory setting 0000. See 8.3 for changing the PIN code). For every digit entered, a * will appear on the display.
3. When the PIN code has been entered correctly, the word 'INSTALL' will show up on the display.
4. Press OK. The display now reads 'INSTALL ZONE'.
5. Set the switch to SEC. Press the ARM HOME button on your Comfort Remote Control. The console will beep to confirm. The display will read 'RMOT 2 SET'.
 - a. If you have more than 2 remote controls installed, it will read e.g. RMOT 3 SET, RMOT 4 SET, ... RMOT 16 SET. You can register up to 16 remote controls.
6. Repeat step 5 for every remote control you wish to register.
7. Press CLEAR to go back to the main menu. Press CLEAR again to quit the menu. To confirm your choice, press 1 for Yes or 2 for No. If you choose Yes, you will quit the menu. If you choose No, you go back to the main menu.

☺ Read chapter 12 for information on replacing the batteries.

4.1.3 Registering a Door/Window Sensor

1. To access the menu, press the menu **↑** or menu **↓** button. The display will now read 'ENTER PIN'.
2. Enter your 4-digit PIN code (factory setting 0000. See 8.3 for changing the PIN code). For every digit entered, a * will appear on the display.
3. When the PIN code has been entered correctly, the word 'INSTALL' will show up on the display.
4. Press OK.
5. Open your door or window. The console will beep to confirm. The display will read 'ZONE 1 SET'.

☺ *A memory space for a sensor is called a zone. If you have more than 1 sensor installed, it will read e.g. ZONE 2 SET, ZONE 3 SET, ... ZONE 30 SET.*

☺ *You can choose in which zone you want to install the sensor. If you want to install the sensor in zone 3, press 3 on the number pad before executing step 5.*

☺ *You will find a table in which you can write down which zone contains which sensor at the back of this user manual. We advise you to write down which sensor you have registered in which zone*

6. Repeat step 5 for every door/window sensor you wish to register.
7. Press CLEAR to go back to the main menu. Press CLEAR again to quit the menu. To confirm your choice, press 1 for Yes or 2 for No. If you choose Yes, you will quit the menu. If you choose No, you go back to the main menu.

☺ *Read chapter 12 for information on replacing the batteries.*

4.2 Motion Detector MS90

1. Battery compartment.
2. Control Indicator – Lights up when a signal is transmitted.
3. TEST button.
4. Sensitivity switch 1/2 – In setting 1 the sensor will instantly react to movement, in setting 2 the sensor is less sensitive and will only react after registering two movements.
5. Tamper contact.

4.2.1 Mounting the Motion Detector MS90

The motion detector works by detecting changes in temperature. Do not mount the detector too close to a heater or air conditioner.

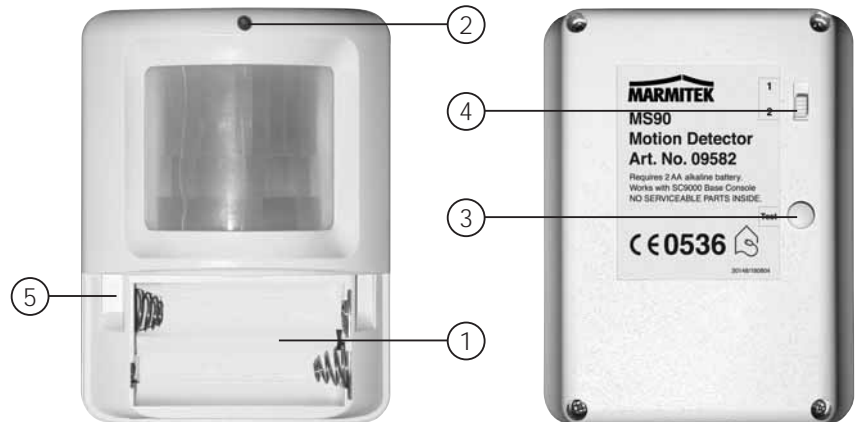

The motion detector has a range of 6-10 m and an angle of 90°. Because of the special lens the sensor 'looks down'. Always mount the MS90 at a height of about 180 cm from the floor and place it in such a way that the detector can cover the area you want to secure. The mounting bracket can be placed at an angle (90°) or directly against the wall.

4.2.2 Using the Motion Detector



1. Open the battery compartment and insert the batteries (2x AA, alkaline).
2. Keep the TEST button (3) pressed for about 4 seconds. The LED will flash once. Release the button. The LED will flash twice. The motion detector has now chosen a unique code, which can be registered with your console.
3. Place the motion detector upside down so that it cannot detect any movement during registration.

Test mode: Testing the location of your motion detector

1. Set the switch to 1.
2. Press the TEST button (3) until the indicator (2) flashes twice.
3. Wait 20 seconds.
4. Walk in front of the sensor. The indicator (2) lets you know when a movement has been detected. This allows you to check whether the sensor has been mounted on the right place.
5. Press the TEST button again to be able to use the sensor as normal.

☺ *After 2 minutes the motion detector will go back to the normal mode.*

4.2.3 Registering a Motion Detector

1. To access the menu, press the menu  or menu  button. The display will now read 'ENTER PIN'.
2. Enter your 4-digit PIN code (factory setting 0000. See 8.3 for changing the PIN code). For every digit entered, a * will appear on the display.
3. When the PIN code has been entered correctly, the word 'INSTALL' will show up on the display.
4. Press OK. The display will read 'INSTALL ZONE'.
5. Press the TEST button of the motion detector or turn it around, so that the sensor will detect movement. The console will beep to confirm. The display will read 'ZONE ...'. SET'.

☺ *A memory space for a sensor is called a zone. If you have more than 1 sensor installed, it will read e.g. ZONE 2 SET, ZONE 3 SET, ... ZONE 30 SET.*

☺ *You can choose in which zone you want to install the sensor. If you want to install the sensor in zone 3, press 3 on the number pad before executing step 5.*

☺ *You will find a table at the back of this user manual in which you can write down which zone contains which sensor. We advise you to write down which sensor you have registered in which zone.*

6. Repeat step 5 for every motion detector you wish to register.
7. Press CLEAR again to quit the menu. To confirm your choice, press 1 for Yes or 2 for No. If you choose Yes, you will quit the menu. If you choose No, you go back to the main menu.

☺ *Read chapter 12 for information on replacing the batteries.*

4.3 Smoke Detector SD10 / SD90

The Marmitek Smoke Detector will make sure you are warned in case of a fire. When you're at home, the built-in siren will be triggered. Combined with your security system the internal siren, the telephone dialler and the lights will be activated. This gives you an optimal warning and makes sure your exits are well lit. If you are away from home, you will receive a warning via your mobile phone.

☺ *The telephone message indicates that the emergency sensor is triggered and that it is not the burglar alarm. This is done by adding an extra message to your own spoken telephone message. This standard message (4 languages: English, German, French, Dutch) is pre-programmed into your system.*

Consult the user manual for your smoke alarm for instructions on using the smoke alarm with your security system.



5. Setting up the security console (SC9000)

5.1 Setting the clock

1. To access the menu, press the menu **↑** or menu **↓** button. The display will now read 'ENTER PIN'.
2. Enter your 4-digit PIN code (factory setting 0000. See 8.3 for changing the PIN code). For every digit entered, a * will appear on the display.
3. When the PIN code has been entered correctly, the word 'INSTALL' will show up on the display.
4. Use the menu buttons **↑/↓** to go to menu item 2. SET CLOCK. Press OK to select this menu item. You can also go to this menu item directly by pressing a 2 on the number pad.
5. Use the number pad to enter the new time (24 hour notation), followed by OK. The display now reads 'INSTALL'.
6. Press CLEAR again to quit the menu. To confirm your choice, press 1 for Yes or 2 for No. If you choose Yes, you will quit the menu. If you choose No, you go back to the main menu.

☺ *If you press CLEAR while entering the time, the time entered will be deleted.*

5.2 Storing phone numbers

The Marmitek SC9000 console is equipped with a telephone dialler. In the case of an alarm up to 6 telephone numbers can be dialled. All persons called will be able to listen to the message you have recorded (5.3). The message needs to be confirmed by the person answering the phone by pressing a 0 on their phone. The telephone dialler then knows the next number does not need to be called.

You are not allowed to use emergency numbers, i.e. the police, unless you have been granted special permission.

First make a list with the phone numbers you want to enter, in the order they need to be dialled. If you have connected the console via an ISDN phone system, you may need to add a 0 in front of the telephone number to get an external line.

1. To access the menu, press the menu **↑** or menu **↓** button. The display will now read 'ENTER PIN'.
2. Enter your 4-digit PIN code (factory setting 0000. See 8.3 for changing the PIN code). For every digit entered, a * will appear on the display.
3. When the PIN code has been entered correctly, the word 'INSTALL' will show up on the display.
4. Use the menu buttons **↑/↓** to go to menu item 3. PHONE NUMS. Press OK to select this menu item. You can also go to this menu item directly by pressing a 3 on the number pad.
5. Use the menu buttons **↑/↓** to go to the memory space where you want to enter a telephone number (PHONE 1, PHONE 2 ... PHONE 6).
6. Press OK when you have arrived at the memory space. After pressing OK at PHONE 1, the display will read SET PH 1.
7. Enter the telephone number. Press the OFF button for a dial pause (use a dial pause between the extra 0 and the telephone number when the console is connected to an ISDN phone system. A small letter 'P' can now be seen on the display).
8. Press OK. You will now automatically go to the next memory space.
9. Press CLEAR again to quit the menu. To confirm your choice, press 1 for Yes or 2 for No. If you choose Yes, you will quit the menu. If you choose No, you go back to the main menu.

☺ *If you press CLEAR while entering a telephone number, the number entered will be deleted.*

☺ *If you program less than 6 numbers, the console will try to contact you at these numbers several times in case of an alarm. As soon as the call is confirmed, the console will stop dialling out.*

5.3 Recording your own message

You can record your own message that will be used by the telephone dialler. The message can be up to 12 seconds long. Make sure the message is not too short, because this will cause a long silence when the message is played.

☺ *Example: This is the security system of Press 0 after this message to hear what is going on in my house. Please take the steps that we agreed.*

1. To access the menu, press the menu **↑** or menu **↓** button. The display will now read 'ENTER PIN'.
2. Enter your 4-digit PIN code (factory setting 0000. See 8.3 for changing the PIN code). For every digit entered, a * will appear on the display.
3. When the PIN code has been entered correctly, the word 'INSTALL' will show up on the display.
4. Use the menu buttons **↑/↓** to go to menu item 4. MESSAGE. Press OK to select this menu item. You can also go to this menu item directly by pressing a 4 on the number pad.
5. Press 1 for RECORD.
6. The display will now read 'PLEASE WAIT'.
7. When the display reads 'SPEAK NOW' you can record your message (max. 12 seconds). The distance to the microphone should be no more than 30 cm.
8. After recording, wait until the RECORD/REPLAY menu comes up again.

9. Press 2 (REPLAY) to listen to the message you have just recorded.
10. Press CLEAR again to quit the menu. To confirm your choice, press 1 for Yes or 2 for No. If you choose Yes, you will quit the menu. If you choose No, you go back to the main menu.

6. Using the security system

6.1 Setting the alarm

The system has two different alarm functions:

ARM AWAY: Full alarm. All sensors are activated.

ARM HOME: Partial alarm. All door/window sensors are activated, but the motion detectors are not armed. This means you can walk around in your home, while the 'shell' of the house is protected.

Switching on the ARM AWAY function

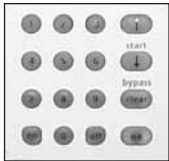

Via the console

Press the ARM AWAY button on the console. The system will be activated after a short delay (delay can be set, see exit delay 8.1). During the delay you will hear a couple of tones at the same pitch.

☺ After switching the system to ARMED AWAY mode, the entry delay will be used for DS90 Door/Window Sensors (DS90 switch set to MAX) when you enter the house. This means you have enough time to switch off the system via the console without triggering the alarm. The delay times can be changed, see 8.1.



Via the Key Chain Remote Control KR21

Press the ARM button. The alarm is switched on instantly.

Please note: Make sure the front door is closed when you switch on the device.



Via the Comfort Remote Control SH624

Set the switch to SEC. Press the ARM AWAY button. The alarm is switched on instantly.

BASIC OPTIONS

Switching on the ARM HOME function



Via the console

Press the ARM HOME button on the console. The alarm is switched on instantly.



Via the Key Chain Remote Control KR21

You cannot switch on the ARM HOME function with your remote control.



Via the Comfort Remote Control SH624

Set the switch to SEC. Press the ARM HOME button. The alarm is switched on instantly.



6.2 Panic alarm

The panic alarm can be switched on in case of an emergency, independent of whether the security system is switched on or off.

☺ *The telephone message indicates the emergency sensor is triggered and that it is not the burglar alarm. This is done by adding an extra message to your own spoken telephone message. This standard message (4 languages: English, German, French, Dutch) is pre-programmed into your system.*

You can activate the panic alarm in two ways:



1. Activate the alarm via the KR21 Key Chain Remote Control
Keep the bottom two buttons of the remote control pressed. The panic alarm is instantly triggered. Depending on the console settings the siren will be triggered or not (see 9.1).



2. Activate the alarm via the SH624 Comfort Remote Control
Press the red PANIC button. The panic alarm is instantly triggered. Depending on the console settings the siren will be triggered or not (see 9.1).

6.3 What happens when the alarm goes off?

1. Siren

The built-in siren will be triggered. You can choose to turn the siren off (silent alarm, see 9.1). If the console is working on the emergency batteries, the siren will not be used, to save battery power.

2. The telephone dialler

After the last digit of the first telephone number has been dialled, the spoken message will be played back and repeated several times. If the call is answered by pressing 0, the console will stop calling. If the call is not answered, the second up to the sixth number are dialled until one of these calls is confirmed by pressing 0. The person who receives the phone call can listen to what is going on in the building for one minute. The siren is switched off while you are listening.

The console will remain on alert. If the alarm goes off again later, the telephone dialler will be activated again.

6.4 Disarming the system

Press DISARM on your remote control. The display will indicate the zone that is causing the alarm. To remove this message, press ARM and then DISARM.

You can also switch off the system by entering your PIN code on the number pad of the console. After entering your PIN code the display will read 'DISARMED'.

6.5 Error messages

If a zone number is slowly flashing on the display, this means the system has noticed an error with that sensor. Possible causes are empty batteries (see chapter 12), range problems (1.2) or the sensor has been tampered with (opened up). The status of all sensors is checked after the security system is switched on. If a problem is found, you will hear the two-tone 'problem signal'. If a sensor (e.g. zone 9) indicates there is a problem, a message is shown on the display.

An open window or door:	OPEN ZONE 9
A tamper message:	TAMPER ZONE 9
Empty batteries or range problems:	PROBLEM ZONE 9

You need to solve the tamper problem before switching on the system (e.g. by closing the top compartment on the console).

☺ *Both the console and the DS90 and MS90 are equipped with a tamper contact. If anyone tries to open the console or sensor while the alarm is activated, the alarm will be triggered. If the alarm is NOT activated, you will see an error message on the console display.*

In all other cases you can choose not to activate the sensor concerned (bypass). You need to press CLEAR while the error message is shown and then activate the alarm again. The zone indicator of the sensor concerned will now flash quickly.

If there are more sensors causing problems, the information on the next sensor will be displayed.

The bypass is valid until you switch off the alarm (Disarm).

7. Prevention and comfort - 'Home Automation'

7.1 Introduction

Marmitek Home Automation makes your home more comfortable, saves energy and offers security, both when you are at home and away. For some people Home Automation means setting the lights with the same remote control they use for the TV; for others it is a completely computerised system that adjusts to their way of life. Marmitek offers you the choice.

Your Marmitek system is equipped with functions to secure your home. The system uses an intelligent process to control the lighting in your house, so that it appears as if you are at home.

The Marmitek X-10 technology also offers you several so-called comfort functions. You can e.g. wirelessly control lamps connected to Marmitek Lamp/Dimmer Modules with your remote control or via the number pad on your console.

Every lamp controlled by the system needs to be equipped with a Marmitek X-10 module. The LM12 Lamp/Dimmer Module from the TotalGuard set is such a module (optional for the SafeGuard, art. no. is country specific, see www.marmitek.com). These modules are easy to install (Plug & Play) and are also available separately, which means you can expand the system as you wish.

A few of our Marmitek Plug & Play modules:



LM12



AM12



LM15

LM12 Lamp/Dimmer Module Plug-in module to switch and dim lighting.

AM12 Device/Switch Module. Plug-in module to switch lighting and electrical equipment.

LM15 Bayonet Lamp Module Bayonet or Screw-In Module to switch lighting.

More information on these modules can be found on www.marmitek.com or you can contact your dealer.

7.2 Addressing your modules



An address can be set for every Marmitek X-10 module. This address consists of a HOUSECODE (A-P) and a UNITCODE (1-16). The HOUSECODE of all your components needs to be set to the same letter code (keep all the HOUSECODES set to A. See 10.6 for more information.). With the UNITCODE you can give every module its own number, so that they can be individually controlled (via the number pad on your console or with the SH624 Comfort Remote Control).

7.3 Installing the LM12 Lamp/Dimmer Module (standard for TotalGuard, optional for SafeGuard)

1. HOUSECODE SWITCH
To set up the system address. Leave the switch set to A.
2. UNITCODE SWITCH
To set up the module number. Leave the switch set to 1.
3. WALL SOCKET
To connect the lamps you want to switch using the module.
4. FUSE
The fuse protects the lamp/dimmer module against a power overload. If the fuse blows, it can only be replaced by another fuse of the same type.

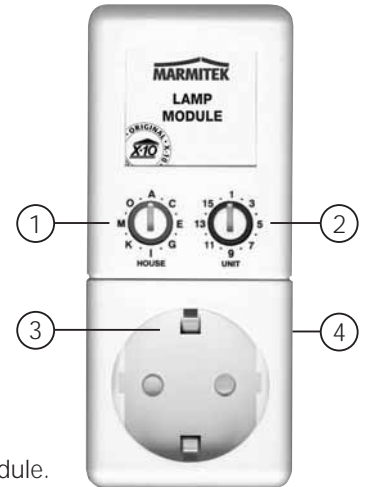

INSTALLATION LM12:

Plug the lamp/dimmer module into a free wall socket and plug your lamp (40-300W) into the module. To avoid damage, do not plug in any other loads - such as household equipment or TL/PL lights - into the module. Please use an AM12 Device/Switch module or a LM15 Bayonet Lamp Module for these types of loads.

7.4 Alarm functions of the Lamp/Dimmer Modules

When switching on the system via the console, the lamps on A1 and A2 will be switched on during the exit delay. As soon as the system is activated, the lamp will be switched off.

When switching on the alarm via your remote control, the lamps will be switched on and off quickly to indicate the system is activated (comparable to the alarm system on your car).

In the case of an alarm the lights connected to lamp/dimmer modules with addresses A1 and A2 will flash. After 4 minutes the lights will remain on.

7.5 Comfort functions of the KR21 Key Chain Remote Control



☺ *Switch and dim lights remotely. Switch the garden lamps on from your bedroom when you hear suspicious noises.*

Press the 'LIGHTS ON' button. The lamps on addresses A1 and A2 will be switched on.
Press the 'LIGHTS OFF' button. The lamps on addresses A1 and A2 will be switched off.

7.6 Comfort functions of the SH624 Comfort Remote Control

☺ *Switch and dim lights remotely. Switch the garden lamps on from your bedroom when you hear suspicious noises.*

Switch (4) SEC setting:

The bottom five buttons (1) are used to switch the Marmitek X-10 modules with corresponding addresses (UnitCodes 1-5).

Use the green button (3) to dim lamps connected to a lamp/dimmer module.

ALL LIGHTS ON (2): To switch on all lamp/dimmer modules with one press of a button.

ALL LIGHTS OFF (2): To switch off all the modules (both lamp and device modules) with one press of a button.

SWITCH (4) IN SETTING 1:

1 8: To switch Marmitek X-10 Home Automation modules with corresponding addresses (UnitCodes 1-8).

SWITCH (4) IN SETTING 2:

916: To switch Marmitek X-10 Home Automation modules with corresponding addresses (UnitCodes 9-16).

Leave the HouseCode switch (5) set to A for now (see 10.6 for more information).

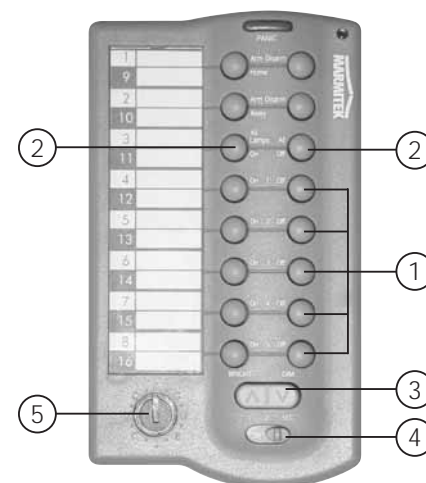

7.7 Comfort functions of the security console

You can also control the modules using the console. If you do not see a menu, the console is in HOME CONTROL mode. The display will read HOME CONTROL. To control a module with UnitCode 1, press 1 followed by ON or OFF.

If you want to control module 12, press 1, then 2, followed by ON or OFF.

7.8 Setting the timer

You can turn on the lighting at pre-programmed times, so that it appears as if you are at home.

1. To access the menu, press the menu \uparrow or menu \downarrow button. The display will now read 'ENTER PIN'.
2. Enter your 4-digit PIN code (factory setting 0000. See 8.3 for changing the PIN code). For every digit entered, a * will appear on the display.
3. When the PIN code has been entered correctly, the word 'INSTALL' will show up on the display.
4. Use the menu buttons \uparrow/\downarrow to go to menu item 9. SET TIMER. Press OK to select this menu item. You can also go to this menu item directly by pressing a 9 on the number pad.
5. The display will read 'NEW TIMER'. Press OK.

☺ *Use the menu buttons \uparrow/\downarrow to check timers you previously set. The top menu item is always called NEW TIMER, unless all 12 timers have been set.*

6. The display will read UNIT NUMBER. Use the number pad to enter the UNITCODE of the desired module (1-16). Example: If you enter 12, the display will read TIMER 12 ON. The lowest line will read " : " .
7. Enter the time you want to lights to be switched on (24 hour notation). If you make a mistake, press CLEAR. Press ON when you only want to enter the time the lights need to be switched on.
8. Press OK. The display now reads TIMER 12 OFF. The lowest line will read " : " .

9. Enter the time you want to lights to be switched off (24 hour notation). If you make a mistake, press CLEAR. Press OK when you do not want to enter a switch-off time.
10. The bottom line on the display now reads 1. DAILY.
11. Use the menu buttons \uparrow/\downarrow to select:
 1. DAILY: The timer setting is executed daily.
 2. ONCE ONLY: The timer setting is only used today.
 3. RANDOM: The timer setting is executed daily, but varies within the hour entered (if you entered 20:30, the time may vary between 20:00 and 20:59).
 4. ARMED ONLY: The timer setting is only executed when the system is in ARMED AWAY mode.
12. Make your choice and press OK. The display now reads 'NEW TIMER'.
13. Press CLEAR again to quit the menu. To confirm your choice, press 1 for Yes or 2 for No. If you choose Yes, you will quit the menu. If you choose No, you go back to the main menu.

7.9 Clearing the timer settings

1. To access the menu, press the menu \uparrow or menu \downarrow button. The display will now read 'ENTER PIN'.
2. Enter your 4-digit PIN code (factory setting 0000. See 8.3 for changing the PIN code). For every digit entered, a * will appear on the display.
3. When the PIN code has been entered correctly, the word 'INSTALL' will show up on the display.
4. Use the menu buttons \uparrow/\downarrow to go to menu item 9. SET TIMER. Press OK to select this menu item. You can also go to this menu item directly by pressing a 9 on the number pad.
5. The display will read 'NEW TIMER'.
6. Use the menu buttons \uparrow/\downarrow to check timers you set before. The timers are shown in the following format:

12 ON 12:40
OFF 18:30
7. When a timer is shown, you can press CLEAR to delete the timer.
8. You need to confirm your choice (CLEAR TIMER). Press 1 for Yes and 2 for No.
9. Press CLEAR again to quit the menu.

EXTRA OPTIONS

8. Advanced system functions

8.1 Setting the delays

You can set a number of delay times via the menu DELAYS:

ENTRY DELAY	The time you get to switch off the system after entering your house (factory setting 30 seconds).
EXIT DELAY	The time you get before the system is switched on when you leave your house (factory setting 60 seconds).
ANSWER DELAY	Delay before the system picks up the phone when dialling in (11.2, factory setting 5 seconds).
DIAL DELAY	Delay before the system calls out in case of an alarm (factory setting 30 seconds).

Setting the delays:

1. To access the menu, press the menu **↑** or menu **↓** button. The display will now read 'ENTER PIN'.
2. Enter your 4-digit PIN code (factory setting 0000. See 8.3 for changing the PIN code). For every digit entered, a * will appear on the display.
3. When the PIN code has been entered correctly, the word 'INSTALL' will show up on the display.
4. Use the menu buttons **↑/↓** to go to menu item 8. DELAYS. Press OK to select this menu item. You can also go to this menu item directly by pressing an 8 on the number pad.
5. Select ENTRY DELAY, EXIT DELAY, ANSWER DELAY or DIAL DELAY and press OK.
6. Enter the time required (1-99 seconds). Press OK. Press CLEAR to delete the values entered.
7. Press CLEAR again to quit the menu.

☺ *The entry delay only works for the DS90 Door/Window Sensor if set to MAX. MS90 motion detectors will respond instantly.*

8.2 Clearing the memory of your security system

You can delete sensors, remote controls, timers or all settings via the menu MEMORY CLEAR.

☺ *The PIN code is never erased. This code can only be reset by a Marmitek Authorised Service Center.*

1. To access the menu, press the menu **↑** or menu **↓** button. The display will now read 'ENTER PIN'.
2. Enter your 4-digit PIN code (factory setting 0000. See 8.3 for changing the PIN code). For every digit entered, a * will appear on the display.
3. When the PIN code has been entered correctly, the word 'INSTALL' will show up on the display.
4. Use the menu buttons **↑/↓** to go to menu item 6. MEMORY CLEAR. Press OK to select this menu item. You can also go to this menu item directly by pressing a 6 on the number pad.
5. Select CLEAR ALL SENSORS, CLEAR ALL REMOTES, CLEAR ALL TIMERS or MASTER RESET.
6. You are now asked to CONFIRM CLR. Press 1 for Yes or 2 for No.
7. Press CLEAR again to quit the menu.

CLEAR ALL SENSORS	Remove a registered sensor.
CLEAR ALL REMOTES	Remove a registered remote control or SD10 smoke detector.
CLEAR ALL TIMERS	Remove all timer settings at once.
MASTER RESET	Clear the memory

8.3 Changing the access code (PIN)

The access code is your personal secret code. After changing this code, you are the only one who has access to the settings on the console. You also use this code to disarm the alarm via the number pad. Make sure you memorise the code, because only a Marmitek Authorised Service Center can help you reset the code to the factory setting (0000). The Service Center will charge you for resetting the console.

1. To access the menu, press the menu **↑** or menu **↓** button. The display will now read 'ENTER PIN'.
2. Enter your 4-digit PIN code (factory setting 0000). For every digit entered, a * will appear on the display.
3. When the PIN code has been entered correctly, the word 'INSTALL' will show up on the display.
4. Use the menu buttons **↑/↓** to go to menu item 5. NEW PIN. Press OK to select this menu item. You can also go to this menu item directly by pressing a 5 on the number pad.
5. Enter your new PIN code (4 digits). The new PIN can be seen on the display. Check if you entered the correct PIN code and press OK.
6. Press CLEAR again to quit the menu. To confirm your choice, press 1 for Yes or 2 for No. If you choose Yes, you will quit the menu. If you choose No, you go back to the main menu.

9. Advanced security functions

9.1 Disarming the siren for silent alarm

You can set the security system to raise the alarm without sounding the siren (just the telephone dialler and lighting). In case of a burglary, the built-in siren will not be activated (N.B., other sirens installed will still work). The siren is turned on in the factory settings.

1. To access the menu, press the menu **↑** or menu **↓** button. The display will now read 'ENTER PIN'.
2. Enter your 4-digit PIN code (factory setting 0000. See 8.3 for changing the PIN code). For every digit entered, a * will appear on the display.
3. When the PIN code has been entered correctly, the word 'INSTALL' will show up on the display.
4. Use the menu buttons **↑/↓** to go to menu item 7. OPTIONS. Press OK to select this menu item. You can also go to this menu item directly by pressing a 7 on the number pad.
5. Use the menu buttons **↑/↓** to go to menu item SIREN. Press OK to select this menu item.
6. Choose 1 for SIREN ON or 2 for SIREN OFF.
7. Press CLEAR again to quit the menu. To confirm your choice, press 1 for Yes or 2 for No. If you choose Yes, you will quit the menu. If you choose No, you go back to the main menu.

9.2 Activating the chime

The console can, when switched off, sound a chime – ding-dong – when a door armed with a door/window sensor is opened. This ensures that you will always hear if someone is entering your house or small children open a door. This function is activated in the factory settings.

1. To access the menu, press the menu **↑** or menu **↓** button. The display will now read 'ENTER PIN'.
2. Enter your 4-digit PIN code (factory setting 0000. See 8.3 for changing the PIN code). For every digit entered, a * will appear on the display.
3. When the PIN code has been entered correctly, the word 'INSTALL' will show up on the display.
4. Use the menu buttons **↑/↓** to go to menu item 7. OPTIONS. Press OK to select this menu item. You can also go to this menu item directly by pressing a 7 on the number pad.
5. Use the menu buttons **↑/↓** to go to menu item CHIME. Press OK to select this menu item.

EXTRA OPTIONS

6. Choose 1 for CHIME ON or 2 for CHIME OFF.
7. Press CLEAR again to quit the menu. To confirm your choice, press 1 for Yes or 2 for No. If you choose Yes, you will quit the menu. If you choose No, you go back to the main menu.
8. If you see a note (↓) on the display, the chime is activated.

☺ *The chime function also works for the wired inputs on zones 31 and 32.*

☺ *The chime function of the wired inputs on zones 31 and 32 always works and cannot be switched off. If you want to deactivate the chime, use the wired input of the door/window sensor.*

9.3 Using wired inputs

The SC9000 console has two inputs for wired sensors. These sensors need to be of type NC (normally closed contacts). There should not be any power on these inputs (potential-free).

Connecting a wired sensor:

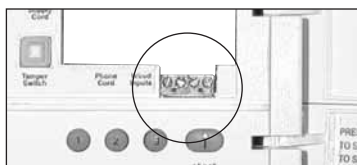

1. Open the top compartment on your console.
2. You will see two wired inputs.
3. Remove the wire bridge and connect your wired sensor.
4. Close the top compartment of your console and enter your PIN code to remove the word TAMPER from the display.
5. The wired sensor is now ready for use.

☺ *The two screws on the left are for zone 32, the two on the right for zone 31.*

9.4 Adding a wired sensor to the Door/Window Sensor DS90

The DS90 Door/Window Sensor has a contact for an extra wired sensor. These sensors need to be of type NC (normally closed contacts). There should not be any power on this contact (potential-free).

A few examples:

- Securing a window with multiple magnetic contacts.
- Adding extra sensors to your Marmitek system, e.g. smoke detectors, temperature sensors, sensors to detect electrical failures, etc.

1. Open the transmitter part of the DS90 by removing the screw.
2. Remove the wire bridge from the connection for the wired sensor (2).
3. Connect your sensor.

The wired contact has its own zone on the console. You can register the contact using the procedure in 4.1.3 (to register a sensor, activate the alarm with your sensor in step 5).

☺ *The setting of the MIN/MAX switch (entry delay) of the DS90 is valid for both the magnetic contact and the wired sensor.*

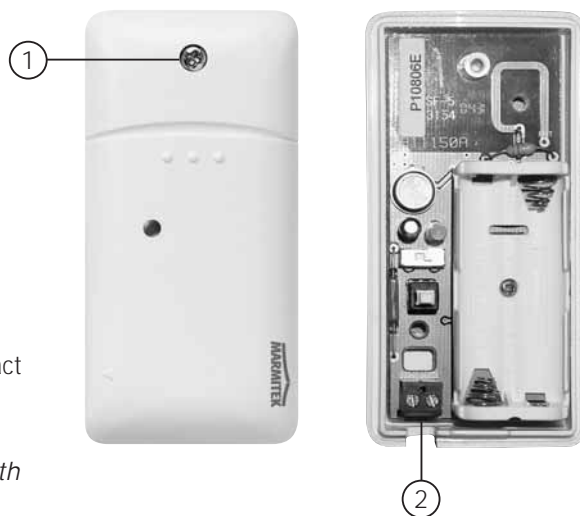





9.5 Emergency sensors (always mode)

Your system also gives you the option to turn any sensor registered with the system into a so-called emergency sensor. An emergency sensor will also activate the security system when the system is not switched on. When an emergency sensor triggers an alarm, you will hear 'Alarm cause by emergency sensor' before the spoken message you recorded.

A few examples:

- A panic button connected to the wired input on the console.
- A door or window that should not be opened at any time.
- A temperature or level sensor that warns you when a certain value or level is exceeded.

Transforming a sensor:

1. To access the menu, press the menu  or menu  button. The display will now read 'ENTER PIN'.
2. Enter your 4-digit PIN code (factory setting 0000. See 8.3 for changing the PIN code). For every digit entered, a * will appear on the display.
3. When the PIN code has been entered correctly, the word 'INSTALL' will show up on the display.
4. Use the menu buttons  to go to menu item 7. OPTIONS. Press OK to select this menu item. You can also go to this menu item directly by pressing a 7 on the number pad.
5. Use the menu buttons  to go to menu item SENSOR MODE. Press OK to select this menu item.
6. The display now reads SET ALWAYS SENSORS. You can see on your display (top and bottom) which zones and sensors have been registered.







7. If you want to turn zone 31 into an emergency sensor, enter 31 on the number pad and press OK. Zone number 31 will start flashing.
8. If you also want to turn zone 5 into an emergency sensor, enter 5 on the number pad and press OK. Zone number 5 will start flashing.
9. If you want to turn zone 31 into a normal sensor again, enter 31 on the number pad and press OK. Zone 31 will stop flashing.
10. Press CLEAR again to quit the menu.

☺ *Make sure the DS90 Door/Window Sensor is set to MIN if you want the message to be passed on without a delay (see 8.1).*

9.6 Sensor 27-32 Marmitek X-10 ON/OFF trigger function

The Marmitek SC9000 console is equipped with a sensor trigger function for sensors 27 to 32.

9.6.1 Apply/Cancel a sensor

1. To access the menu, press the menu  or menu  button. The display will now read 'ENTER PIN'.
2. Enter your 4-digit PIN code (factory setting 0000. See 8.3 for changing the PIN code). For every digit entered, a * will appear on the display.
3. When the PIN code has been entered correctly, the word 'INSTALL' will show up on the display.
4. Use the menu buttons  to go to menu item 7.OPTIONS. Press OK to select this menu item.
5. Use the menu buttons  to go to menu item SENSOR 27-32. Press OK to select this menu item. The zones the user had been installed will light up.

EXTRA OPTIONS



6. Press the zone number (27-32) followed by the ON or OFF key to set the zone. If entry correctly, the selected zone will become flashing.
7. Repeat last step for additional zones.
8. Select the same zone again will clear it.
9. Press CLEAR to go back to the main menu. Press CLEAR again to quit the menu. To confirm your choice, press 1 for Yes or 2 for No. If you choose Yes, you will quit the menu. If you choose No, you go back to the main menu.

9.6.2 Using the Marmitek X-10 ON/OFF trigger function

ARM the system. If the zone selected by procedure above has triggered the system. The House code of the system (default A)+1, unit code 7-12 + ON or OFF (selected by user in procedure above) will be transmitted via the mains.



Example, if user selected 32+OFF in setup, X-10 B12 OFF will be transmitted via the mains with 32 wire opened.

9.7 Deregistering a Door/Window Sensor

1. To access the menu, press the menu  or menu  button. The display will now read 'ENTER PIN'.
2. Enter your 4-digit PIN code (factory setting 0000. See 8.3 for changing the PIN code). For every digit entered, a * will appear on the display.
3. When the PIN code has been entered correctly, the word 'INSTALL' will show up on the display.
4. Press OK.
5. Enter the number of the zone you want to erase on the number pad and press CLEAR.
6. You are asked to confirm CLEAR ZONE 1. YES 2. NO.
7. Press 1 to erase the zone. The zone number is shown on the display.
8. Press CLEAR again to quit the menu.

 *Zones 31 and 32 cannot be erased.*

9.8 Deregistering a Motion Detector

1. To access the menu, press the menu  or menu  button. The display will now read 'ENTER PIN'.
2. Enter your 4-digit PIN code (factory setting 0000. See 8.3 for changing the PIN code). For every digit entered, a * will appear on the display.
3. When the PIN code has been entered correctly, the word 'INSTALL' will show up on the display.
4. Press OK.
5. Enter the number of the zone you want to erase on the number pad and press CLEAR.
6. You are asked to confirm CLEAR ZONE 1. YES 2. NO.
7. Press 1 to erase the zone. The zone number is shown on the display.
8. Press CLEAR again to quit the menu.

 *Zones 31 and 32 cannot be erased.*

10. Advanced Home Automation functions

In chapter 7 you learnt how to use the Marmitek X-10 Home Automation options of your security system. But there is a lot more. Marmitek not only has the Plug & Play modules described, but a large number of built-in switches, sun blind switches, remote controls and special modules which can be used in combination with your security system. With these modules you can control nearly everything that is electrically powered in your home via your security system. See www.marmitek.com (Product group Home Automation) for more information.

Your system has a few extra standard functions that use the Marmitek X-10 system:

10.1 Checking the status of the security system

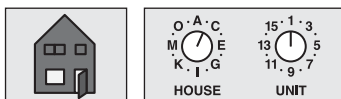

Set a Marmitek X-10 module to address B1. This Home Automation module is now automatically switched on as soon as the security system is activated. When the system is disarmed, the module is also switched off. Example: You can connect a table lamp to this X-10 module. If the system is activated, this lamp is always turned on. This means you can instantly see if the system is activated when you are outside.

10.2 Installing an extra siren (Marmitek PH7208, art. no. 08929)

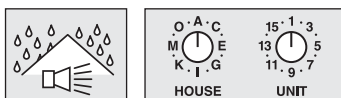

Set the siren PH7208 to address A1. To avoid false alarms, the system waits a few seconds after triggering the alarm before the siren is activated. The siren will give a piercing two-tone signal for 4 minutes. After these 4 minutes the siren is automatically switched off (or sooner if the alarm is switched off).

ATTENTION: When using a Marmitek security system, the extra sirens will always work in case of an alarm, even when the system is set to silent alarm! The Siren PH7208 is meant for indoor use and can be plugged into any wall socket.

10.3 Using an external universal siren

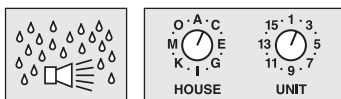

You can also add sirens and warning lights that are not part of the Marmitek range. Please use a separately available Marmitek AD10 (art. no. 08933), AW12 (09463) or the AM12 (art. no. country specific, see www.marmitek.com).

Set this module to address B2. The module is switched on in case of an alarm and switched off after 4 minutes.

10.4 Transceiver function

The Marmitek X-10 range contains several wireless remote controls that you can use to control your Marmitek X-10 modules (such as a universal remote control for your TV, audio equipment and Marmitek X-10). These remote controls use the RF system, which means the remote control signal goes through walls and ceilings. See www.marmitek.com for more information. Your console will convert these remote control RF signals to X-10 signals and transmit them via the mains. You can then control the Marmitek X-10 modules using these transmitters.

10.5 All Home Automation functions at a glance

Name	Description	Module set to address
Comfort lighting	You can switch your lighting using the buttons Lights ON and Lights OFF on your key chain remote control.	A1 and A2
Exit delay	Lights are switched on during the exit delay.	A1 and A2
Alarm lighting	In the case of an alarm, the lights will flash during 4 minutes and then remain on.	A1 and A2
Status indicator	The lights are switched on when the system is set to ARM AWAY.	B1
External Siren PH7208	Extra 110dB siren.	A1 or A2
Extra universal siren	Connect your own siren to a Marmitek AM12 or AD10 module.	B2
Sensor trigger function	In case of an alarm on zone 27 to 32 an ON or OFF command is sent	B7 B8 B9 B10 B11 B12

This table uses the unchanged settings for the basic console address.





10.6 Basic address for Home Automations functions

The basic address is set to control multiple Home Automation modules on the SC9000. The standard basic address is A1. The A in this address is called the HouseCode. The HouseCode of the console, the remote controls and the Home Automation modules all have to have the same letter. The 1 in the basic address is called the UnitCode. If your neighbours also have a Marmitek security system, it may be necessary to change the basic addresses and the addresses of your Marmitek X-10 modules.

If you change the HouseCode of the console, the addresses for the Home Automation functions also change. Example: You change the HouseCode from A into C.

Name	Description	Module set to address
Comfort lighting	Reacts to the Lights ON and Lights OFF button on your key chain remote control.	C1 and C2
Exit delay	Lights are switched on during the exit delay.	C1 and C2
Alarm lighting	In the case of an alarm, the lights will flash during 4 minutes and then remain on.	C1 and C2
Status indicator	The lights are switched on when the system is set to ARM AWAY.	D1
External Siren PH7208	Extra 110dB siren.	C1 or C2
Extra universal siren	Connect your own siren to a Marmitek AM12 or AD10 module.	D2
Sensor trigger function	In case of an alarm on zone 27 to 32 an ON or OFF command is sent	D7 D8 D9 D10 D11 D12

To change the HouseCode:

1. To access the menu, press the menu  or menu  button. The display will now read 'ENTER PIN'.
2. Enter your 4-digit PIN code (factory setting 0000. See 8.3 for changing the PIN code). For every digit entered, a * will appear on the display.
3. When the PIN code has been entered correctly, the word 'INSTALL' will show up on the display.
4. Use the menu buttons  to go to menu item 7. OPTIONS. Press OK to select this menu item. You can also go to this menu item directly by pressing a 7 on the number pad.
5. Use the menu buttons  to go to menu item HOUSECODE. Press OK to select this menu item.
6. Use the menu buttons  to select the desired HouseCode and press OK.
7. Press CLEAR again to quit the menu.





Did you already have several Marmitek X-10 modules installed before installing the security system? Then you may need to change the basic UnitCode for the system. This means you do not need to change the addresses of the existing system.

If you change the UnitCode of the console, the addresses for the Home Automation functions also change. Example: You change the UnitCode from 1 into 5:

Name	Description	Module set to address
Comfort lighting	Reacts to the Lights ON and Lights OFF button on your key chain remote control.	A5 and A6
Exit delay	Lights are switched on during the exit delay.	A5 and A6
Alarm lighting	In the case of an alarm, the lights will flash during 4 minutes and then remain on.	A5 and A6
Status indicator	The lights are switched on when the system is set to ARM AWAY.	B5
External Siren PH7208	Extra 110dB siren.	A5 or A6
Extra universal siren	Connect your own siren to a Marmitek AM12 or AD10 module.	B6
Sensor trigger function	In case of an alarm on zone 27 to 32 an ON or OFF command is sent	B11 B12 B13 B14 B15 B16

☺ If you set the UnitCode for the console to e.g. A16, the comfort lighting will get addresses A16 and A1.

To change the UnitCode:

1. To access the menu, press the menu  or menu  button. The display will now read 'ENTER PIN'.
2. Enter your 4-digit PIN code (factory setting 0000. See 8.3 for changing the PIN code). For every digit entered, a * will appear on the display.
3. When the PIN code has been entered correctly, the word 'INSTALL' will show up on the display.
4. Use the menu buttons  to go to menu item 7. OPTIONS. Press OK to select this menu item. You can also go to this menu item directly by pressing a 7 on the number pad.
5. Use the menu buttons  to go to menu item UNITCODE. Press OK to select this menu item.
6. Use the menu buttons  to select the desired UnitCode and press OK.
7. Press CLEAR again to quit the menu.

11. Telephone functions

11.1 Calling the security system

The SC9000 alarm system is equipped with a call-in function. This means that you can ring your console remotely via any telephone or mobile phone. You can also control your lights and devices via your phone. The system has a built-in speech chip that guides you through the menus.

11.2 Activating the call-in function

The call-in function is switched off in the factory settings. You can switch the function on via the menu OPTIONS/ANSWER TYPE.

You can choose one of the following three options:

ANSWER ON:

Call-in activated. The time delay before the console answers the phone can be set in the menu DELAYS/ANSWER DELAY (see 8.1). The standard delay is 30 seconds. If you use an answer phone or voice mail, we advise you to use option 3: VOICE MAIL.

ANSWER OFF:

the call-in function is deactivated (standard setting).

VOICE MAIL:

Call-in activated. Choose this option when you use the standard voicemail system offered by your telecom supplier. To access the console, ring your home number twice. Let the phone ring for 10 seconds the first time. Hang up the phone and ring the number again after 10 seconds, but within 30 seconds. The console will answer the phone.

Setting the call-in function:

1. To access the menu, press the menu **↑** or menu **↓** button. The display will now read 'ENTER PIN'.
2. Enter your 4-digit PIN code (factory setting 0000. See 8.3 for changing the PIN code). For every digit entered, a * will appear on the display.
3. When the PIN code has been entered correctly, the word 'INSTALL' will show up on the display.
4. Use the menu buttons **↑/↓** to go to menu item 7. OPTIONS. Press OK to select this menu item. You can also go to this menu item directly by pressing a 7 on the number pad.
5. Use the menu buttons **↑/↓** to go to menu item ANSWER TYPE. Press OK to select this menu item.
6. You can now select ANSWER ON, ANSWER OFF or VOICE MAIL.
7. Use the menu buttons **↑/↓** to go to the desired menu item and press OK.
8. Press CLEAR again to quit the menu.

11.3 Operating the alarm functions via an outside phone

1. Call your home number. The console will answer.
2. You will hear 'Please enter PIN'. Enter your PIN code.
3. If your PIN is correct, you will hear 'PIN accepted'. If your PIN is incorrect, you will hear 'Error'.
4. Press 0 followed by * to activate your security system.
5. Press 0 followed by # to deactivate your security system.

When you press 9 9 followed by *, the console will do a status check:

The status can be:

ARMED HOME: The system is set to ARM HOME mode.
ARMED AWAY: The system is set to ARM AWAY mode.

DISARMED:	The system is switched off.
EMERGENCY ALARM:	The alarm has been triggered by a PANIC BUTTON on a remote control or a Marmitek SD10 Smoke Detector.
ALARM IN ZONE 3:	(example with zone 3). The alarm has been triggered by the sensor in zone 3 (wireless sensor or emergency sensor).

11.4 Operate lights and equipment via an outside phone

1. Call your home number. The console will answer.
2. You will hear 'Please enter PIN'. Enter your PIN code.
3. If your PIN is correct, you will hear 'PIN accepted'. If your PIN is incorrect, you will hear 'Error'.
4. Press 4 *: The Marmitek X-10 module with UnitCode 4 will be switched on. You will hear '4 ON' to confirm.
5. Press 4 #: The Marmitek X-10 module with UnitCode 4 will be switched off. You will hear '4 OFF' to confirm.

12. Changing the batteries

When used normally the batteries in sensors and remote controls last about a year. The life span of batteries does depend on how often a sensor is activated.

Preferably use alkaline batteries, but never rechargeable batteries (rechargeable batteries are not strong enough and will go flat within a few months, even when they are seldom used).

Console – 4xAA batteries

The emergency batteries in the console ensure that even during a power cut the entire system stays operational for another 12 hours (if there is no alarm).

- If there is an alarm during a power cut, the console will not activate the siren to save battery power. The telephone dialler works normally.
- If there is a power cut and the emergency batteries are flat, all settings are stored, because these are programmed into a non-volatile memory (EEPROM). The clock will need to be reset.
- When you decide to turn off the security system for a longer period (e.g. renovation work), remove the batteries from the console to avoid them going flat.
- If the emergency batteries are empty or not installed, the BATTERY indicator on the console will flash.
- If you open up the battery compartment to change the batteries, the word 'TAMPER' will be visible on the display. After inserting the batteries and closing the compartment, enter your PIN code (factory settings 0000, see 8.3) to remove the word 'TAMPER'.

Key Chain Remote Control KR21 – 2x CR2016 batteries

De KR21 wordt geleverd met volle batterijen. Wanneer de indicator op de KR21 zwak gaat branden, dienen de batterijen vervangen te worden.

- A new KR21 contains fully charged batteries. If the indicator light on the KR21 is not very bright, the batteries should be replaced.
- Open the remote control (back) with your nails or a small screwdriver. Use CR2016, 3V lithium batteries (2x).
- To retain the unique code for your remote control, the batteries need to be replaced within 30 seconds.
- If after replacing the batteries the console does not respond to your remote control, press the ARM button on your remote control for 4 seconds to reactivate the remote. Then release the button. You now need to reregister the remote control, using the procedure described in 3.1.2.

☺ *When pressing the ARM button the LED should flash quickly a few times. When the LED lights up and stays lit, you need to reactivate the KR21.*

☺ *To avoid losing a memory space, you can remove the old code for your remote control from the memory (see 8.2).*

EXTRA OPTIONS

Comfort Remote Control SH624 – 4x AAA batteries

Wanneer de indicator op de SH624 zwak gaat branden, dienen de batterijen vervangen te worden.

- If the indicator light on the SH624 is not very bright, the batteries should be replaced.
- First set the switch on the front of the remote control to SEC. Now open the battery compartment on the back of the remote control and replace the batteries within 30 seconds.
- If the console does not respond to your remote control after replacing the batteries, press the PANIC button on your remote control. You now need to reregister the remote control, using the procedure described in 3.1.2.

☺ *To avoid losing a memory space, you can remove the old code for your remote control from the memory (see 8.2).*

Door/Window Sensor DS90 – 2x AAA batteries

The console checks the battery status of the DS90 sensor. If the batteries are too weak, the console will indicate a 'PROBLEM' and the zone number will flash.

- Normally the unique code of the sensor will remain in the memory (if you replace the batteries within 30 seconds). After replacing the batteries you can check whether the sensor still has its unique code. You do this by opening the door or window. If the sensor has remembered its code, the console display will read ZONE x OPEN (zone number for x). If nothing happens, the door/window sensor needs to be reregistered (see 4.1.3). Delete zones you do not use anymore (see 9.7) or install the sensor in the same zone as before.

Motion Detector MS90 – 2x AA batteries

The console checks the battery status of the MS90 sensor. If the batteries are too weak, the console will indicate a 'PROBLEM' and the zone number will flash.

- Normally the unique code of the sensor will remain in the memory (if you replace the batteries within 30 seconds). You can check this by setting your system to ARMED AWAY. If the sensor has remembered its code, the alarm will go off when you walk past the sensor. If nothing happens, you need to reregister the motion detector (see 4.2.3). Delete the zone (see 9.8) and reregister the sensor (see 4.2.3).

13. Frequently asked questions

Why does the security system not work?

Check whether you see any text on the console display. If not: check whether the AC adapter is connected to the mains, whether the electrical wire is plugged into the adapter and whether the plug is connected to the console.

Check whether you can control the system via the console. If so, check whether the remote control works by checking whether the control indicator on the remote control flashes when you press e.g. the ARM button.

Change the batteries if necessary and reinstall the remote control.

What to do if a zone indicator flashes slowly?

One of the sensors or motion detectors has not contacted the base console for a longer time. Check the batteries in the sensor or motion detector. Erase the zone and reregister the sensor. Move the sensor so that the signal can reach the console.

If an error is found while setting the alarm, you will hear a repeated two-tone 'error signal'. If a sensor indicates there is a problem (e.g. window opened), you can choose not to activate this sensor.

While the two-tone 'error signal' can be heard, you need to press the CLEAR button and reset the alarm. The zone indicator of the sensor concerned flashes quickly.

What to do if a zone indicator flashes quickly?

You have pressed the CLEAR button to activate the security system while a sensor or motion detector indicated an error. Solve the problem (i.e. close the window, replace the batteries) before activating the zone.

What to do if you hear a repetitive one-tone signal when activating the alarm?

This is normal. When activating the alarm there is an exit delay of one minute to leave your house. You can alter this delay (see 8.1). After one minute the tone will stop and the system will be switched on.

What if you cannot switch the light on or off using the Lights ON or Lights OFF button on the remote control?

Make sure the HouseCode on the console is set to A and the UnitCode to 1 (see 10.6). Set the dials on your lamp/dimmer module to HouseCode A and UnitCode 1.

Make sure the lamp connected to the lamp/dimmer module is on and the lamp is working. Use a different wall socket. Check whether the indicator of the remote control flashes when you press the button. If necessary replace the battery/ies.

When using multiple phases in your house, you may need to couple these phases for Marmitek X-10 signals. See www.marmitek.com for more information.

What if you cannot register the SH624 Comfort Remote Control with the console?

Remove the batteries from the remote control. Keep one of the buttons pressed for a few seconds. Set the switch to SEC. Replace the batteries. Press the PANIC button until the indicator starts flashing. Reregister the remote control with the console.

What to do in case of a false alarm?

Do not mount motion detectors in direct sunlight. Mount motion detectors in such a way they are not aimed at a heater or other heat source.

Is the MS90 pet-friendly?

No. The MS90 is not specifically pet-friendly. These motion detectors do exist (not wireless). Your security system has an extra input for wired sensors (see 9.3). You can also connect the sensor to the external contact of the DS90 sensor (9.4).

TABEL SENSORS

Sensor Nr.	Location	Sensor type
1	_____	_____
2	_____	_____
3	_____	_____
4	_____	_____
5	_____	_____
6	_____	_____
7	_____	_____
8	_____	_____
9	_____	_____
10	_____	_____
11	_____	_____
12	_____	_____
13	_____	_____
14	_____	_____
15	_____	_____
16	_____	_____
17	_____	_____
18	_____	_____
19	_____	_____
20	_____	_____
21	_____	_____
22	_____	_____
23	_____	_____
24	_____	_____
25	_____	_____
26	_____	_____
27	_____	_____
28	_____	_____
29	_____	_____
30	_____	_____
31	_____	Wired input 1
32	_____	Wired input 2

TABEL TELEPHONE NUMBERS

Memory position	Telephone number	Name
1	_____	_____
2	_____	_____
3	_____	_____
4	_____	_____
5	_____	_____
6	_____	_____

TECHNICAL DATA

SC9000 MAIN UNIT

Supply:	230VAC 50 Hz, 4 x AA back-up battery - 24-hour stand-by.
Supply current :	< 80 mA capacitive
Signal transmission:	> 5Vpp in 5 Ohm at 120 kHz \pm 1 kHz
X-10 transmission:	1 pulse burst at 0°, 60° and 120°
Sends X-10 Key codes:	On, Off.
RF receiver frequency:	433.92 MHz
Certification:	TBR21 approved telephone selector
Integrated siren:	95 dB (A)
Capacity:	Up to and incl.: 30 sensors (door/ window, motion sensors and/or broken glass sensors) 2 wired inputs and 16 remote controls.
Memory:	6 telephone numbers, (non-volatile) each max. 16 digits
Control panel:	For control of 16 zones and/or macros.
Ambient temperature:	0° C to + 50° C (operation) - 20° C to + 70° C (storage)
Dimensions:	220x140x40mm

MOTION DETECTOR MS90

Power :	2x AA battery
RF Range:	Up to 100m free field, up to 30m through walls and ceilings
PIR range:	180° - 6 meter, in a straight line - 12 meter
Dimensions:	76x100x42mm
Frequency:	433.92 MHz

DOOR/WINDOW SENSOR DS90

Power :	2x AAA battery
Range:	Up to 100m free field, up to 30m through walls and ceilings
Dimensions:	44x86x20mm
Frequency:	433.92 MHz

KR21E KEY CHAIN REMOTE

Power :	2x CR2016 3V Lithium battery
Range:	Up to 100m free field, up to 30m through walls and ceilings
Dimensions:	38x57x12mm
Frequency:	433.92 MHz

Standard for TotalGuard, optional for SafeGuard:

COMFORT REMOTE CONTROL SH624

Power :	4x AAA battery
Range:	Up to 100m free field, up to 30m through walls and ceilings
Dimensions:	123x22x70mm
Frequency:	433.92 MHz

LM12 LAMP MODULE

Supply voltage:	230V \pm 10% 50 Hz
Supply current :	< 20 mA capacitive
Making capacity:	40W to 300W (normal light bulbs only)
Dimmer Speed:	4.4s from 100% to 0% \pm 0.2s
Signal sensitivity:	15 mVpp min 50 mVpp max at 120 kHz
Input impedance:	> 55 Ohm (L - N) at 120 kHz
Ambient temperature:	-10° C to + 50° C (operation) -20° C to + 70° C (storage)
Dimensions:	52x122x33mm (without plug)

DECLARATION OF CONFORMITY

Hereby, Marmitek BV, declares that this SafeGuard/TotalGuard is in compliance with the essential requirements and other relevant provisions of the following Directives:

Directive 1999/5/EC of the European Parliament and of the Council of 9 March 1999 on radio equipment and telecommunications terminal equipment and the mutual recognition of their conformity

DIRECTIVE 2004/108/EC OF THE EUROPEAN PARLIAMENT AND OF THE COUNCIL of 15 December 2004 on the approximation of the laws of the Member States relating to electromagnetic compatibility

Directive 2006/95/EC of the European Parliament and of the Council of 12 December 2006 on the harmonisation of the laws of Member States relating to electrical equipment designed for use within certain voltage limits

Directive 2002/95/EC of the European Parliament and of the Council of 27 January 2003 on the restriction of the use of certain hazardous substances in electrical and electronic equipment

MARMITEK BV - P.O. BOX 4257 - 5604 EG EINDHOVEN – THE NETHERLANDS



Environmental Information for Customers in the European Union

European Directive 2002/96/EC requires that the equipment bearing this symbol on the product and/or its packaging must not be disposed of with unsorted municipal waste. The symbol indicates that this product should be disposed of separately from regular household waste streams. It is your responsibility to dispose of this and other electric and electronic equipment via designated collection facilities appointed by the government or local authorities. Correct disposal and recycling will help prevent potential negative consequences to the environment and human health. For more detailed information about the disposal of your old equipment, please contact your local authorities, waste disposal service, or the shop where you purchased the product.

The following copyrights and trademarks are applicable:

Marmitek is a trademark of Marmidenko BV

SafeGuard is a trademark of Marmitek BV

TotalGuard is a trademark of Marmitek BV

All rights reserved.

Copyright and all other proprietary rights in the content (including but not limited to model numbers, software, audio, video, text and photographs) rests with Marmitek B.V. Any use of the Content, including without limitation, distribution, reproduction, modification, display or transmission without the prior written consent of Marmitek is strictly prohibited. All copyright and other proprietary notices shall be retained on all reproductions.

